

Creative Woodworking N.W., Inc.

1036 S.E. Taylor * Portland, Oregon 97214
Phone:(503) 230-9265 * Fax:(503) 232-9082
www.Creativewoodworkingnw.com

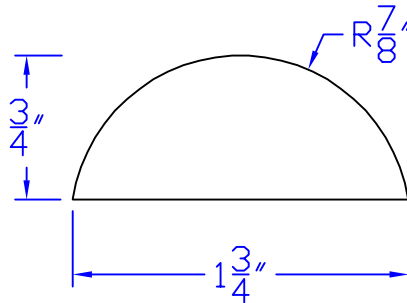

RNDS062

$\frac{3}{4}$ " x $1\frac{3}{4}$ "
 $\frac{7}{8}$ " RADIUS